

Data Sheet



Article number: 0108051

Description: Retaining ring JK 34 DIN 984

Measures

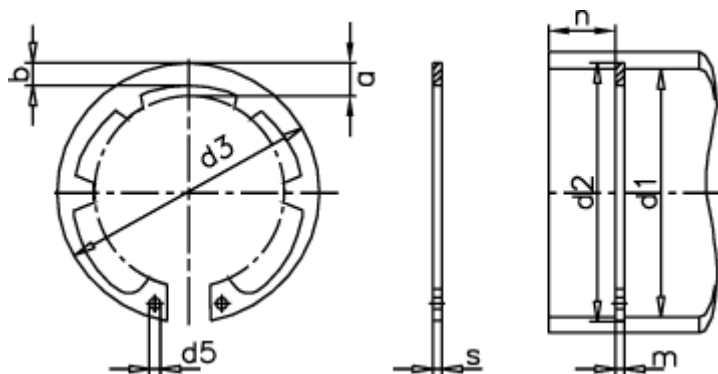

a max	= 5.3	FN kN	= 15.4	s	= 1.50
AN mm ²	= 92.6	FRg kN	= 6.3	t	= 0.85
b	= 3.4	FR kN	= 26.2	tol	= +0,25
d1	= 34	g	= 1.5	tol	= -0.06
d2	= 35.7	K kN-mm	= 50.0	tol	= +0,50-0,25
d3	= 36.5	m min	= 1.60	Tong	= ZGJ-2
d5 min	= 2.5	Nominal drive	= 2.5	Weight kg/1000	= 3.80
Description	= JK 34	Number of serrations	= 6		